

Sento soffitto due flat datasheet

LED ceiling mounted luminaire with a flat base for mounting on cavity box. Connection to a remote constant voltage source (converter). Modular LED head-body-system allows free combination of different surfaces of head, body and base. Removable head for configuration and maintenance purposes, LED changeable. Heads available with one sided or double sided light output, power of light source 18W or 26W.

Lighting effect changeable by using optional inserts, dichroic color filters can be added. Adjustment via heat-decoupled carbon pin (fixation of head against rotation optional). Controllable via external dimmer (depending on the power supply unit) or via »touchless control« with gestures at the head. Further options: up (with surface mount transformer).

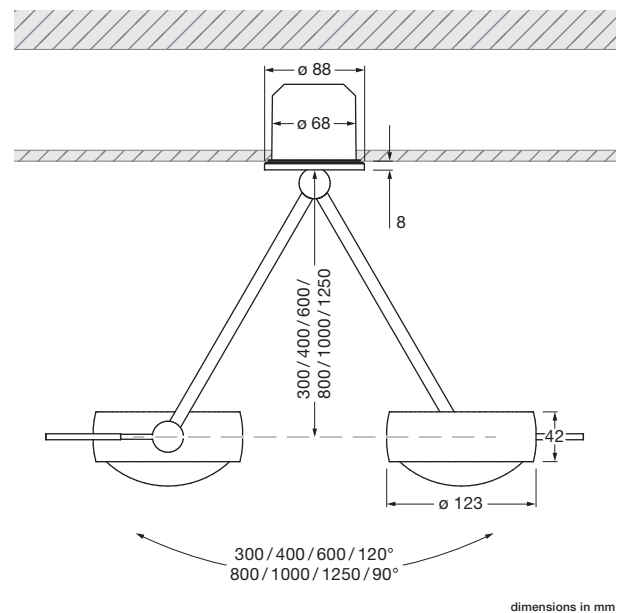

dimensions in mm

technical data Sento soffitto due flat

properties	material	aluminium, steel chrome-plated, painted or anodised, plastic, glass, optical plastic		
	length	300 / 400 / 600 / 800 / 1000 / 1250 mm		
	rotation head	360°		
	swivel range	300, 400, 600 mm 120° / 800, 1000, 1250 mm 90°		
	weight	3.1 kg (300, 400, 600, 800) / 3.5 kg (1000, 1250)		
surface	head	matt gold, rose gold, bronze, shiny chrome, matt chrome, glossy white, matt white, matt black		
	body	matt white, matt black, shiny chrome, matt chrome		
	base	shiny chrome, glossy white, matt chrome, matt white		
Occhio LED	average life time	> 50.000 hrs		
	energy efficiency class	A+ / A		
	power	26 W / 18 W		
	color rendering index	perfect color; CRI Ra 97	high flux; CRI Ra 85	
	color temperature	2700, 3000 K	3000, 3500, 4000 K	
	recommended use	residential and public	public	
electricity	dimming	»touchless control« and Occhio air (optional) or via trailing-edge phasecut dimmer* (depends on driver)		
	power supply unit	remote, driven by constant voltage source 48V DC / min. 30W per head		
	permitted operating conditions	max. 30°C for indoor use only		

*trailing-edge phasecut dimmer and Occhio air not combinable



Sento soffitto due flat lighting effects

 head single sided

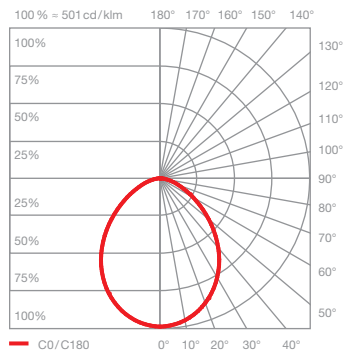
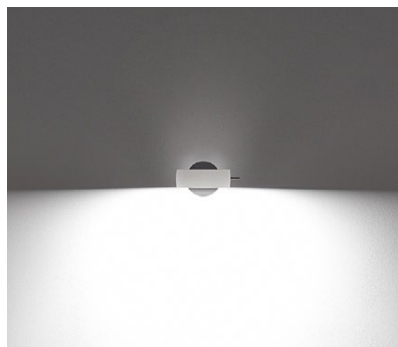

Sento B

diffuse light

insert: diffusor glass

luminous flux:	perfect color	26W	1370lm
	high flux	26W	1870lm
	perfect color	18W	1000lm
	high flux	18W	1370lm

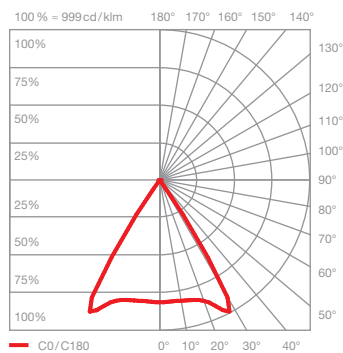

Sento C

directed light
beam angle approx. 80°

insert: lens

luminous flux:	perfect color	26W	1570lm
	high flux	26W	2150lm
	perfect color	18W	1140lm
	high flux	18W	1570lm

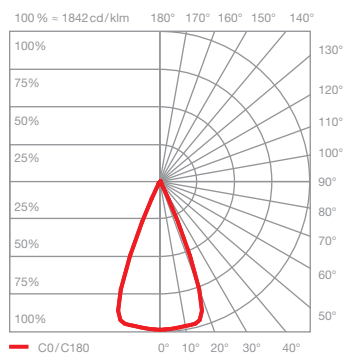
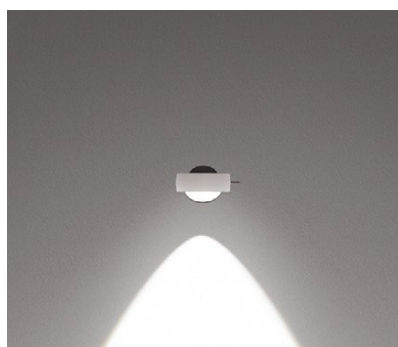

Sento S40

directed light
beam angle approx. 40°

insert: spot lens, lens
soft edge glass

luminous flux:	perfect color	26W	1560lm
	high flux	26W	2130lm
	perfect color	18W	1130lm
	high flux	18W	1560lm

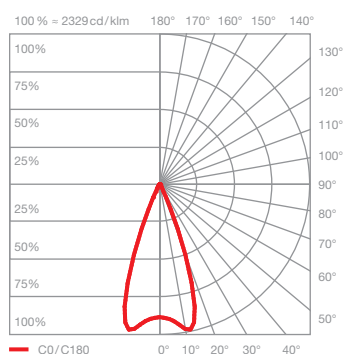
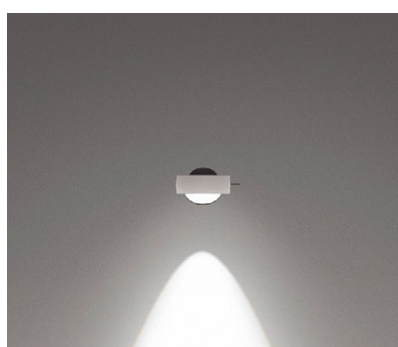

Sento S30

directed light
beam angle approx. 30°

insert: spot lens, lens
fresnel lens

luminous flux:	perfect color	26W	1530lm
	high flux	26W	2080lm
	perfect color	18W	1110lm
	high flux	18W	1530lm

Sento soffitto due flat lighting effects

 head double sided

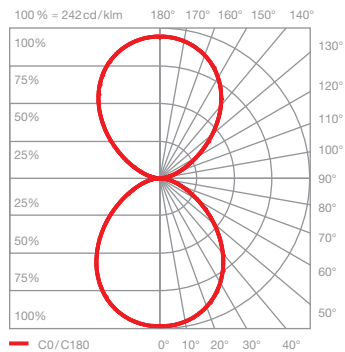
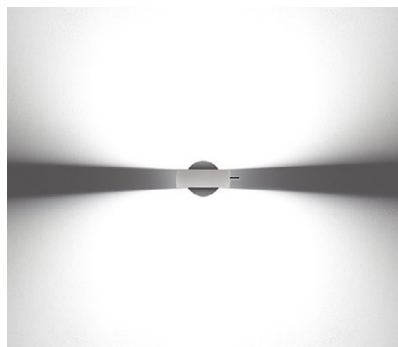

Sento A

diffuse light in both directions

insert: diffusor glass
diffusor glass

luminous flux:	perfect color	26W	1500lm
	high flux	26W	2040lm
	perfect color	18W	1090lm
	high flux	18W	1500lm

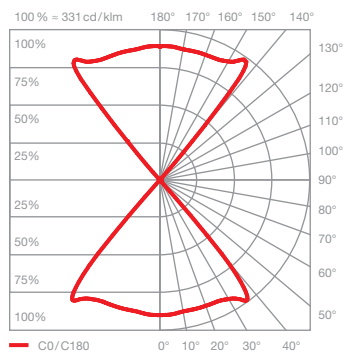

Sento D

directed light in both directions
beam angle approx. 80°

insert: lens
lens

luminous flux:	perfect color	26W	1750lm
	high flux	26W	2390lm
	perfect color	18W	1270lm
	high flux	18W	1750lm

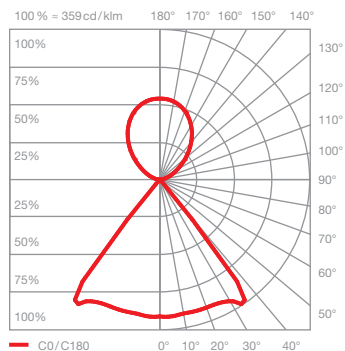
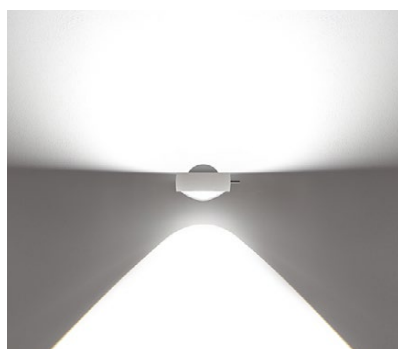

Sento E

diffuse up light
directed down light
beam angle approx. 80°

insert: diffusor glass
lens

luminous flux:	perfect color	26W	1620lm
	high flux	26W	2200lm
	perfect color	18W	1170lm
	high flux	18W	1620lm