

io sospeso up datasheet

LED ceiling spotlight with spherical head and lens optics; version with surface mount transformer for fitting onto solid ceiling with cable outlet; power supply with internal power source (converter). Available as version with continuous height adjustment or fixed adjustable height. Movable in any direction thanks to Occhio 3D kinematics with two pivots set at an angle of 22.5° to each other; operation via heat-insulated grip pads. Head can be taken off for maintenance; replaceable LED. Power 18 W or 13 W (preselectable); dimmable via customer-supplied dimmable ballast or by hand movement control via touchless sensor (can be deactivated). Lighting effect can be changed through optional inserts; dichroitic color filters can be additionally inserted. Surface combinations of head, pads, body and base can be configured as desired; pads changeable.

Other versions: sospeso flat (with flat base), sospeso track (1 or 3 phase tracks).

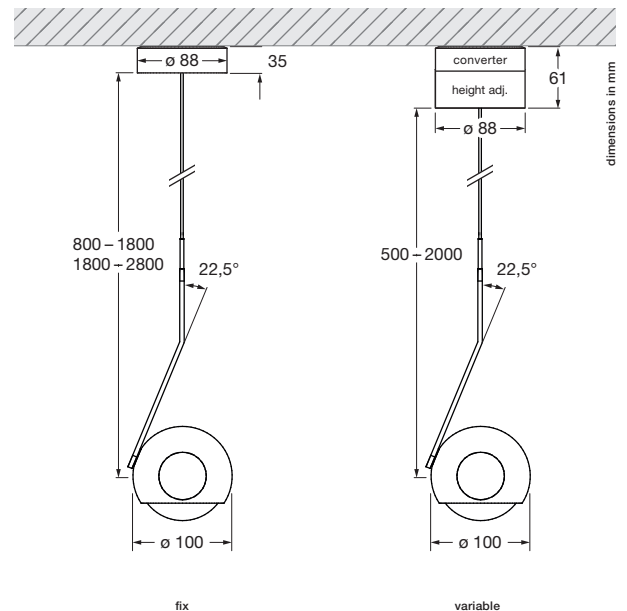
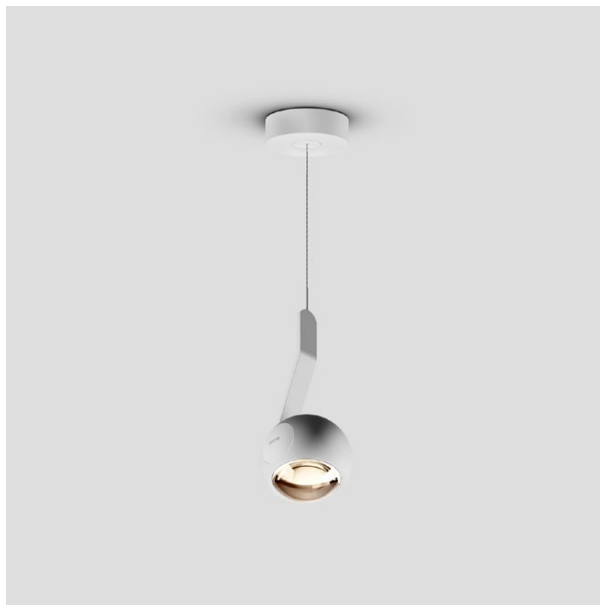

technical data io sospeso up

properties	material	aluminium, zinc chrome-plated or painted, optical plastic, glass	
	turning range head/body	360°	
	length	variable: 500 – 2000 mm / fix: max. 800 – 1800 mm / 1800 – 2800 mm	
	weight	variable: 1.5 kg / fix: 1.1 kg	
surface	head	matt gold, rose gold, bronze, shiny chrome, matt chrome, glossy white, matt white, matt black	
	pads	rose gold, bronze, shiny chrome, matt chrome, glossy white, matt white, matt black	
	body	shiny chrome, matt chrome, matt white, matt black	
	base	shiny chrome, matt chrome, glossy white, matt white, matt black	
Occhio LED	average life time	> 50.000 hrs	
	energy efficiency class	A ++ / A +	
	power	18 W (preselectable 18 W / 13 W)	
	color rendering index	perfect color; CRI Ra 97	high flux; CRI Ra 85
	color temperature	2700 K, 3000 K	3000 K, 3500 K, 4000 K
	recommended use	residential and commercial	commercial
electricity	dimming	via »touchless control« (can be deactivated), alternative with trailing edge phase-cut dimmer or Occhio air*	
	power supply unit	integrated operating voltage 230 V AC	
	permitted operating conditions	max. 30°C for indoor use only	

* For a list of compatible dimmers, see www.occhio.de/dim_en



io sospeso up lighting effects

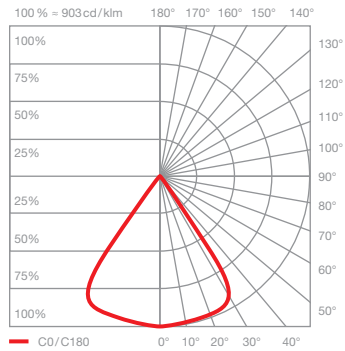

io C
directed light
(approx. 80°)

inserts: lens

luminous flux:	perfect color	18W	1170lm
	high flux	18W	1610lm
	perfect color	13W	800lm
	high flux	13W	1170lm

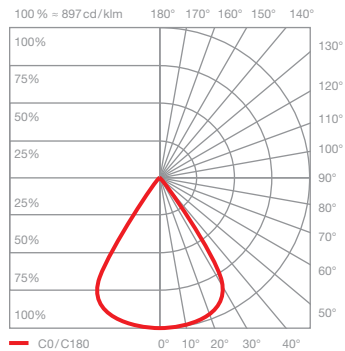
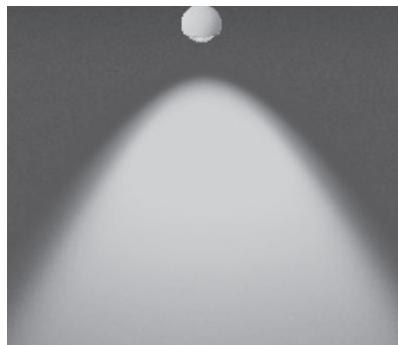

io C with soft edge glass
directed light with soft contour of the
beam angle
(approx. 80°)

inserts: lens
soft edge glass

luminous flux:	perfect color	18W	1070lm
	high flux	18W	1470lm
	perfect color	13W	740lm
	high flux	13W	1070lm

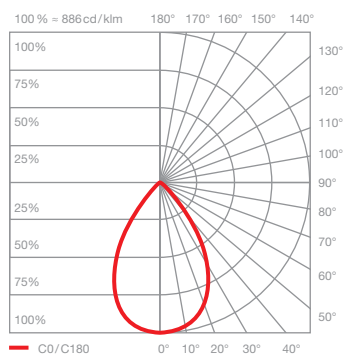
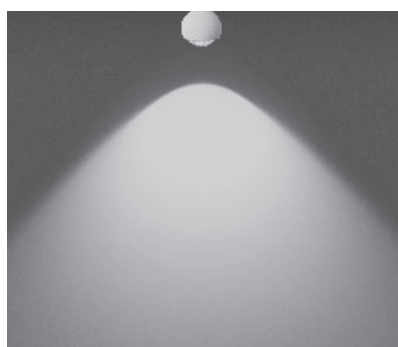

io C with satinised glass
diffused light with soft widening of the beam
angle
(approx. 100°)

inserts: lens
satinised glass

luminous flux:	perfect color	18W	910lm
	high flux	18W	1250lm
	perfect color	13W	630lm
	high flux	13W	910lm

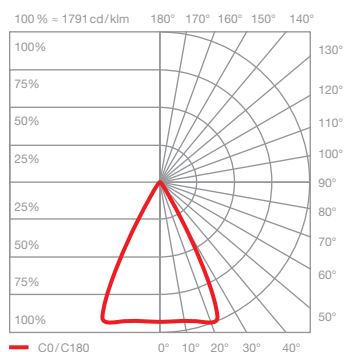
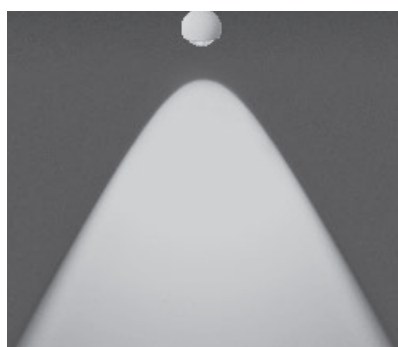

io C with fresnel lens
bundled light
beam angle approx. 60°

inserts: lens
fresnel lens

luminous flux:	perfect color	18W	990lm
	high flux	18W	1360lm
	perfect color	13W	680lm
	high flux	13W	990lm