

Beat Light Stout

BLS04 / BLA02UL

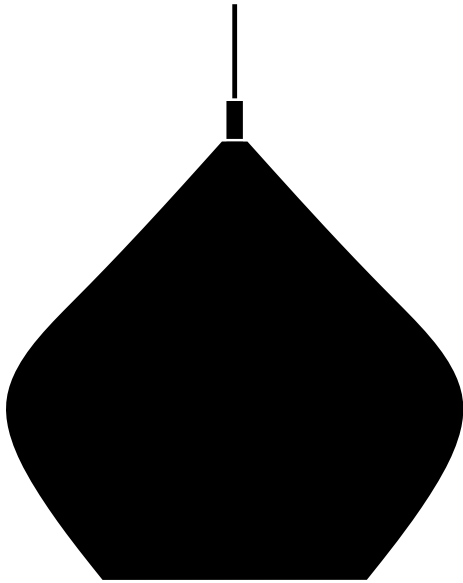

www.tomdixon.net

Tom
Dixon.

1

Contents

BLS04
Beat Light - Stout

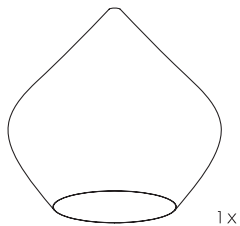

BLA02EU
Pendant Large Fitting UL

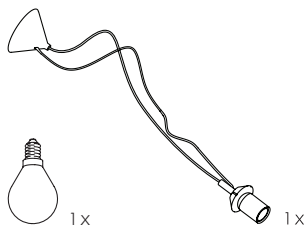

2

Before you start

- Please read the instructions carefully before you commence the installation.
- Retain this instruction booklet for future reference. If the product is sold, please ensure the booklet is left with the appliance for the benefit and safety of the new owner.

Warning



- Electricity can be dangerous.
- Before commencing installation ensure the power supply is disconnected at the fuse box.
- The lighting is for use in a normal dry domestic indoor environment.
- Do not attempt to fit installation unless you are competent.
- If in any doubt consult a qualified electrician to complete electrical installation.

Cleaning Instructions and Care

- Clean with a soft dry cloth only.
- Do not use polishing agents, water or abrasive materials when cleaning.
- Always switch off the electricity supply before cleaning.

Installation

- Take care when handling and installing to avoid damage to the product.
- Avoid mounting the fitting on a damp surface such as newly painted or plastered area. This may cause discoloration to the finish.
- The finish is only guaranteed against normal non aggressive atmospheric conditions. To prevent rusting, the light should not be fitted in locations near the sea, polluted atmospheres or near heating.
- Unless otherwise marked / illustrated the lighting is for use in a domestic indoor environment.

Tools

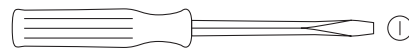

Bulb replacement

100W Max. E26 Globe. Dispose of old bulbs with care.

Important

For your safety: If the electrical cable of the light is damaged, it should be completely replaced by the manufacturer or his service agent or other qualified person.

Pendant Assembly

1

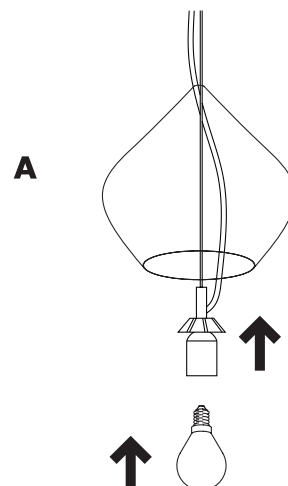

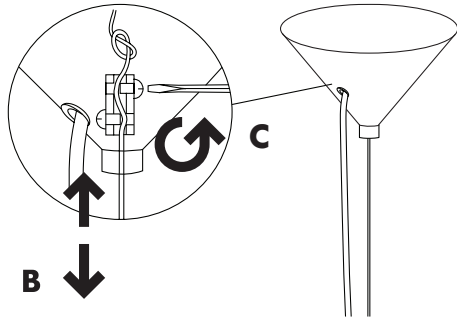

3

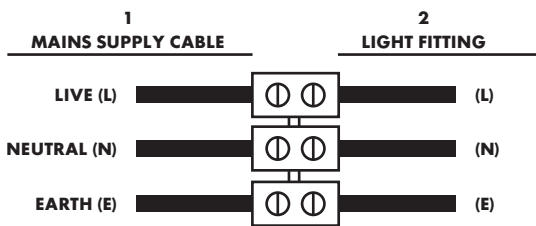
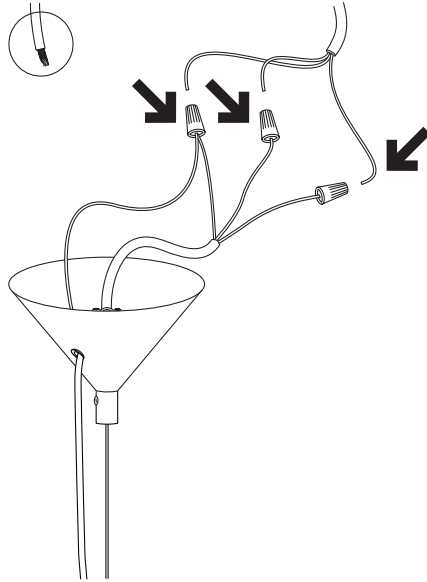

Check that:

- You have identified the mains cable correctly.
- The connections are tight.
- You have clamped the conductor not the cables' insulation.
- No loose strands have been left out from the connector block.

Mains supply cable (1): Live (L) = Brown or Red / Neutral (N) = Blue or Black / Earth (E) = Green / Yellow or Green. Light fitting (2): (L) = Clear / (N) = Clear / (E) = Green / Yellow or Green.

Make sure the suspension wire rather than the cable is taking the weight of the luminaire.

Screw fix the metal bracket into the ceiling ensuring the power source is still accessible.

Position the junction box in the ceiling void.

4

